

MANoo – GETTING STARTED GUIDE

CRYO & NANO PRODUCTS

JPE



+31 (0) 43 3585 777

www.jpe.nl

Aziëlaan 12

6199 AG Maastricht-Airport
The Netherlands

Property of: JPE

Author: JPE

Filename: CNP_MANoo_Ro4_Getting-Started.docx

Page 1 / 15

Last update: 2021-01-15

Revision: 04

Doc status: Released

CONTENTS

1. INTRODUCTION	4
1.1 Document version	4
2. APPLICABLE DOCUMENTS	5
2.1 Products User Manual	5
2.2 Software User Manual	5
3. SAFETY	6
3.1 Instructions	6
3.2 Safety Rules	6
4. GETTING STARTED	8
4.1 Inside the box	8
4.2 Setup for first time use	8
4.3 Installing additional Modules in an existing Controller (CPSC)	9
5. EXTENDING ELECTRICAL AND OPTICAL CONNECTIONS	11
5.1 Altering Ambient Cables (ACL)	11
5.2 Adding electrical components	11
5.3 Adding optical components	14
6. CLEANING OF PARTS	15

RELEVANT DOCUMENTATION

Ref	Title, Author
[1]	
[2]	
[3]	
[4]	
[5]	

DOCUMENT HISTORY

JPE	2019-07-15	Ro1. Creation.
JPE	2020-09-18	Ro2. Update.
JPE	2020-10-15	Ro3. Update.
JPE	2021-01-15	Ro4. Update.

DEFINITIONS

ABBREVIATIONS

1. INTRODUCTION

Thank you for using JPE's Cryo & Nano Products!

This *Getting Started Guide* describes the hardware installation and setup of *Cryo & Nano Positioning Systems* (from here on described as *systems*) using JPE's cryogenic compatible actuators (from here on described as *actuator*). These actuators can be operated by using a (modular) Controller System (from here on described as *controller*).



Please read this document carefully prior to installation and (initial) operation of the controller, (stand-alone) actuators and systems. Failure to observe the safety regulations results in a risk of mortal electric shock and/or damage to the controller(s), actuator(s) and/or system(s)!

JPE shall not be liable for damage or injury resulting from misuse of the controller system(s), actuator(s) and/or device(s) or unauthorized alterations to either of those.

All products mentioned in this manual are intended for use in a laboratory and/or scientific research environment only and may only be installed, maintained and used by higher educated, technical skilled personnel (from here on described as *operators*).

1.1 Document version

This *Getting Started Guide* assumes using the latest products and controller software: **v7.x.yyyymmdd**.

Please note that all content in this document is superseded by any new versions of this document. Visit the JPE website (www.jpe-innovations.com) to obtain the most recent version. All images in this document are for illustrative purposes only.

2. APPLICABLE DOCUMENTS

Alongside this *Getting Started Guide* there are other manuals that need to be consulted prior to using the products.

2.1 Products User Manual

Each product has its own separate *User Manual (MANo1-xx)*, which can be found at the product page of each individual product on the JPE website¹. These manuals include electrical and/or optical connection diagrams or specific unpacking instructions for example.

MANo1-01	Cryo Linear Actuator (CLAxxyy)
MANo1-02	Cryo Positioning Systems High Resonance (CPSHR)
MANo1-03	Cryo Bearing Stage (CBS)
MANo1-04	Cryo Stage o2 (CSo2)
MANo1-05	Cryo Translation Stage (CTS) (<i>discontinued</i>)
MANo1-06	Cryo Linear Drive (CLD)
MANo1-07	Cryo Tip/Tilt/Piston Stage (CTTPS)
MANo1-08	Cryo Rotary Motor (CRM)
MANo1-09	Cryo Positioning Systems Controller (CPSC)
MANo1-10	Cryo Vibration Isolation Platform (CVIP)
MANo1-11	Nano Stepper Actuator UHV (NSAU)
MANo1-12	Cryo Linear Scanner (CLS)

2.2 Software User Manual

Read the *Software User Manual (MANo2)*² on how to operate systems and actuators using the controller. This manual includes a detailed instruction list describing the user software.

¹ Visit www.jpe-innovations.com > Cryo & Nano Products

² Visit www.jpe-innovations.com > Cryo & Nano Products > Cryo Positioning Systems Controller (CPSC)

3. SAFETY

3.1 Instructions

In all available products related documents (see chapter 2), important (mostly safety related) information is shown inside a (red colored) solid line bordered box, like this:

Important notes are shown inside a bordered box.

Please note that it is obligatory to follow the instructions mentioned in these bordered boxes! Failing to observe instructions may result in a risk of electric shock! Therefore follow all instructions carefully!

General tips and tricks for handling and using the products are shown inside a (blue colored) dashed bordered box, like this:

Tips and tricks are mentioned inside a dashed bordered box.

3.2 Safety Rules

- 1 Assembly and mounting of actuators and systems may only be carried out when not (electrically or optically) connected to the controller.*
- 2 Always check all cabling, wiring and connectors (electrical as well as optical) on defects prior to connecting to actuators, systems or controllers. Please note that electrical wires and optical fibers to actuators and (inside) systems are fragile parts and should always be handled with great care!*
- 3 Actuators and systems must only be connected to the controller when all actuators and systems have been placed in a safe environment towards the operator(s), i.e. out of reach by the operator(s) when driving them electrically (by using the controller).*
- 4 **Because of design constraints, open voltage contacts are present!** Therefore touching actuators and systems including all cabling and connectors while driving electrically, is not allowed and may result in a dangerous electrical shock! Avoid physically touching unconnected in- or outputs when the controller is powered ON.*
- 5 Always place the controller(s), actuator(s) and system(s) on a sturdy surface or mount, the controller at level (and preferably) on a bench top, desk or 19" rack, and away from any wet or damp locations. Do not cover the top of the controller cabinet! In case of installing in a 19" rack, keep at least 2U height free above the cabinet.*
- 6 Actuator(s) and system(s) can be used in vacuum (vacuum chamber) and/or cryogenic environment (cryostat). Actuator(s) and system(s) must only be operated when the environment is in a defined state. Recommended pressure levels are: $\leq 1e^{-3}$ [mbar] or normal ambient conditions. In between operating is not recommended in order to reduce the risks of electric arcing (Paschen's Law).*
- 7 Do not use the controller in any other way than to operate actuators and systems supplied by JPE and do not operate actuators and systems in any other way than by using the controller supplied by JPE.*

- 8 *The controller is designed to be powered by commonly used 230V AC / 50Hz (European version) or 115V / 60Hz (US version) via a socket with protective earth. Note that it is not possible to switch in between both (i.e. the ordered controller is either the 230V version or the 115V version). Always ensure proper grounding via the protective earth connection of the power inlet.*
- 9 *Do not turn ON the controller immediately after it has been brought from a cool into a warmer environment (risk of condensing water) or vice versa. After unpacking, wait at least 4 hours before using the controller.*
- 10 *Always keep (metal) screw-on caps on the ends of unconnected (optical) cabling and connectors.*
- 11 *Always handle actuators and systems using (powder free, nitrile) gloves and store the products in a closed box when not in use to keep them as clean as possible.*

4. GETTING STARTED

4.1 Inside the box

Depending on the ordered products, the delivery will consist of a large cardboard box with the following items inside:

- [1x] Cardboard box containing:
 - [1x or more] White-colored (membrane) Polypropylene Box(es) with the ordered number of actuators and/or systems
 - [1x] Mains Power cable
 - [1x] USB A to B cable
 - Any product specific accessories, such as for example ACL, AF5, CCR, I1-RSM, PSMIL
- [1x] Modular Controller (CPSC) that consists of a Base Cabinet (CAB) with the ordered plug-in modules (for example CADM2, RSM, OEM2) already installed.

Carefully unpack everything and pay special attention to the white-colored (membrane) polypropylene box: the inner part of the polypropylene box can be taken out and bend in such way that the actuators and/or systems can be easily unpacked. In some cases, the products are fixed onto the inner part of the polypropylene box using nuts and bolts instead of being locked underneath the membrane plastic.

Do not cut the membrane plastic of any of the boxes. Keep the packaging aside in case products need to be returned.

Before continuing, check all parts for any visible defects. If anything found or when in doubt, please contact JPE for further assistance.

4.2 Setup for first time use

Follow all safety rules as listed in Chapter 3!

This following guide assumes connection of the controller to a computer via USB and the use of the Command Line Interface (CLI). Please refer to the Software User Manual for a detailed guide on how to operate systems and actuators via software and (other) available connection options (USB, LAN).

- 1 Unpack and mount the actuator(s) or system(s) according any specific instructions mentioned in the product's User Manual. For an initial test run, use only the standard supplied Ambient Cabling (ACL), Ambient Fiber (AF5), Cryostat Cable for RLS (CCR) or Ambient Connector Kit for RSM (I1-RSM).
- 2 Place the controller on an appropriate surface (for example a sturdy workbench) and make sure that no actuators or systems are connected to the controller.
- 3 Check that the Mains Power Switch on the back of the controller cabinet is in the OFF ("o") position, connect the supplied mains power chord to the IEC inlet on the back and plug the power chord into a protective contact power socket. Make sure the mains power matches the rated input

voltage (label on back panel) and that the top of the cabinet is not covered! (When installed in a 19" rack, make sure at least 2U above is free.)

- 4 Connect the supplied USB cable to the back of the cabinet (connector labelled "USB") and on the other end in to a free USB port.
- 5 Connect each actuator or system to the controller modules according to the instructions mentioned in the product's User Manual.

For easy reference, make a note which actuator or system is connected to which output.

- 6 Controlling actuator(s) or system(s) can be done via software that runs on a Windows OS compatible computer. Download a copy of the latest *User Software* at the JPE website³.
- 7 Power on the cabinet, switch the Mains Power Switch to the ON ("1") position.
- 8 Windows will automatically detect new hardware. Because the controller uses a standard *Human Interface Device* (HID), a suitable driver should be found. This can take a while, but in the end the operating system will display a message that the driver has been installed successfully.
- 9 Wait a few seconds for the controller to boot (there's no visual indication). Open a Windows Command Prompt, navigate to the folder that contains the User Software and type: `cacli MODLIST` followed by `[enter]`. The CLI should return a comma-separated list of all detected modules in the controller, for example: `CADM2,RSM,-,-,-,-`, (where in the example: CADM2 in Slot 1, RSM in Slot 2, Slots 3-6 are empty).
- 10 Now use the `MOV`-command to start moving an actuator. When using a standard **CLA2601** type actuator connected to a CADM2 module in **slot address 1**, you can use the example below to make the actuator do **321** (piezo) steps at **450**Hz and at full **100%** step size:

Command [foll. by enter]	<code>cacli MOV [ADDR] [DIR] [FREQ] [RSS] [STEPS] [TEMP] [STAGE] [DF]</code>
Command (example)	<code>cacli MOV 1 1 450 100 321 293 CLA2601 1</code>
Response (example)	Actuating the stage.

After completing 321 steps, the actuator will automatically stop moving.

This is only a basic example, please consult the *Software User Manual* for more details on all available commands.

- 11 Make sure to turn the controller OFF ("o") before disconnecting any actuators or systems from the controller.

4.3 Installing additional Modules in an existing Controller (CPSC)

Up to 6 function specific modules can be installed in one Base Cabinet (CAB). If additional modules are ordered after initial delivery, these modules can be installed by the customer upon delivery by following the instructions in this section.

³ Consult the Software User Manual (MANo2) for more detailed instructions.

- 1 Make sure to unplug the Base Cabinet (CAB) from the mains supply and wait for at least 10 minutes before inserting (or removing) any Module.
- 2 To insert a module, unscrew the blank filler panel at the first available position (as seen from left to right at the front of the cabinet).

If a sensor (OEM2 or RSM) module is already installed, make sure that the sensor module is always on the right-hand side of all driver (CADM2) modules! So, if necessary, move the sensor module as well. For example:

Slot	Old situation	Incorrect new situation	Correct new situation
1	CADM2	CADM2	CADM2
2	CADM2	CADM2	CADM2
3	OEM2	OEM2	(new) CADM2
4		(new) CADM2	OEM2
5			
6			

- 3 Make sure to tighten all 4 screws of the Module prior to power on of the cabinet.

5. EXTENDING ELECTRICAL AND OPTICAL CONNECTIONS

Because each customer setup is different and there are many options depending on the used cryostat or vacuum chamber, JPE does not supply feedthroughs or additional connectors. There are however some recommended parts that can be used with JPE's Cryo & Nano Products.

This chapter can be used as a reference for connecting and constructing additional (electrical or optical) cabling in between actuator(s) or systems(s) and the (controller) module(s) (if required).

It is not allowed to make any alterations to the actuator's and/or system's Connector Interface PCBs.

Make sure to test all actuators and systems with only the supplied cabling first, before connecting any additional cabling for the intended setup in which the actuators and systems are to be used.

Please note that any soldering must be carried out by qualified personnel only and do double-check correct pin wiring afterwards

Visually check for cable faults and check for possible shorts in between wires and/or in between wires and the actuator or system itself (using a multi-meter) after connecting any additional cabling.

JPE does not assume liability for damages to property or personal injury!

5.1 Altering Ambient Cables (ACL)



Although not recommended, it is allowed to detach (de-solder) the Molex socket connector for final integration in the Customer's setup (for example to connect to a feedthrough). It is vital to make sure that *Signal (SIG)* and *Reference (REF)* wires are not mixed up when soldering the cable to a different connector!

It is not allowed to alter the LEMO connector on the Ambient Cable.

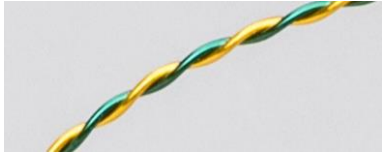

5.2 Adding electrical components

The total DC resistance of all wiring per actuator (CADM2/PSM output to actuator) should not exceed 10[Ω]. The supplied Ambient Cable (ACL) has a resistance of less than 0.5Ω/m. If any other cabling is to be used, it is recommended to use wires with a rated voltage of (at least) 200[V] and a rated current of (at least) 1[A] continuously.

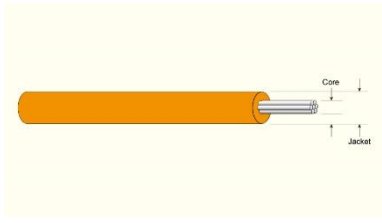
The total DC resistance of all wiring per sensor (RSM output to sensor) is not very critical. If any other cabling is to be used, it is recommended to use wires with a rated voltage of (at least) 50[V] and a rated current of (at least) 0.1[A] continuously.

Recommended wiring		
Lakeshore Duo-Twist DT-32	Cryogenic wire, 32AWG phosphor bronze twisted pair ⁴	
Allectra 301-KAPM-035⁵	Kapton isolated wire, UHV compatible, 27AWG, multi-strand silver plated copper wire 7x0.12mm. <i>Recommended for actuators.</i>	
LewVac KAPW7X010	Kapton isolated wire, UHV compatible, 30 AWG, multi-strand silver plated copper wire, 7x.0.1mm. <i>Recommended for sensors.</i>	

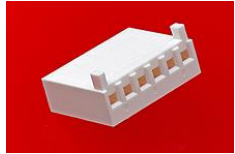
Always check visually for cable or wire faults or possible shorts in between wires and/or in between wires and the actuator(s) / system(s) itself (by using a multi-meter) after installation in the final setup and before connecting the actuator(s) / system(s) to the controller module(s).







Recommended feedthroughs and connectors (can be used for both actuators and sensors)		
Molex KK 22-01-3027⁶	KK® 254 Crimp Housing, Friction Ramp, 2 Circuits, Nylon	
Molex KK 08-50-0032⁷	KK® 254 Cat Ear Crimp Terminal 4809, 22-30 AWG, Hot Tin Dip, Bag	

⁴ Most suitable for in cryogenic applications, however wire is difficult in use (fragile insulation, difficult routing) and the electrical resistance is relatively high (so keep length to bare minimum). Also available as Quad-Twist (QT-32) (2x twisted pair).

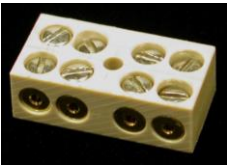
⁵ Also available as ribbon cable (301-KAP-RIB04 for example)

⁶ Also available in various other number of circuits

⁷ Lakeshore Duo-Twist DT-32 (or Quad-Twist QT-32) requires soldering wire to contact (crimp not possible as wire is too thin).

<p>Molex KK 22-27-2021 (or Molex KK 22-05-7028)</p>	<p>KK® 254 Wire-to-Board Header, Vertical (or Right-Angle), with Friction Lock, 2 Circuits, Tin (Sn) Plating, Nylon</p>	
<p>Allectra 360-SC1X4-1.8⁸</p>	<p>PEEK Connector Block, UHV compatible, 4 pins, 1x4 contacts</p>	
<p>LewVac D15-PCONF⁹</p>	<p>Subminiature D Type (D-SUB) UHV PEEK connector, 15p Female.</p>	
<p>LewVac DPINF-25-S¹⁰</p>	<p>UHV female crimp pins for use with LewVac D-SUB UHV PEEK</p>	
<p>Vacom PLUG-SUBD-15-P¹¹</p>	<p>Subminiature D Type (D-SUB) UHV PPS connector, 15p Female.</p>	
<p>Vacom EK-SUBD-F-AWG22-25ST¹²</p>	<p>UHV female crimp pins for use with Vacom D-SUB UHV PPS Connector</p>	
<p>Vacom W-SUBD-15-BASIC¹³</p>	<p>15 pin Sub-D feedthrough acc. MIL-C-24308, weldable</p>	

⁸ Also available in 1x6, 1x8 or 2x2 contacts, visit the Allectra webshop for more information.

⁹ Also available in 9p, 25p or 50p and/or male version, visit the LewVac webshop for more information.

¹⁰ Requires specific crimp tool, get in contact with LewVac for further information.

¹¹ Also available in 9p, 25p, 37p or 50p version, visit the Vacom webshop for more information. PPS is a thermoplastic material similar to PEEK, but with lower water absorption and outgassing (and most likely more cost-efficient than PEEK).

¹² Requires specific crimp tool, but wires can also be soldered to pins. Visit the Vacom webshop for more information.

¹³ Also available in 9p, 25p, 37p or 50p or already welded in KF or CF flange, visit the Vacom webshop for more information.

5.3 Adding optical components

If additional optical fiber cabling is required, make sure to use FC/APC patch cables only. The default connection scheme, using standard Ambient Fibers (AF5) can be seen in the schematic overview below.

Connection options	
[A]	Applies when connecting systems like CPSHR
[B]	Applies when connecting single actuators with the –COE option, it is required to insert the FC/APC female/female adapter (one for each actuator will be supplied).

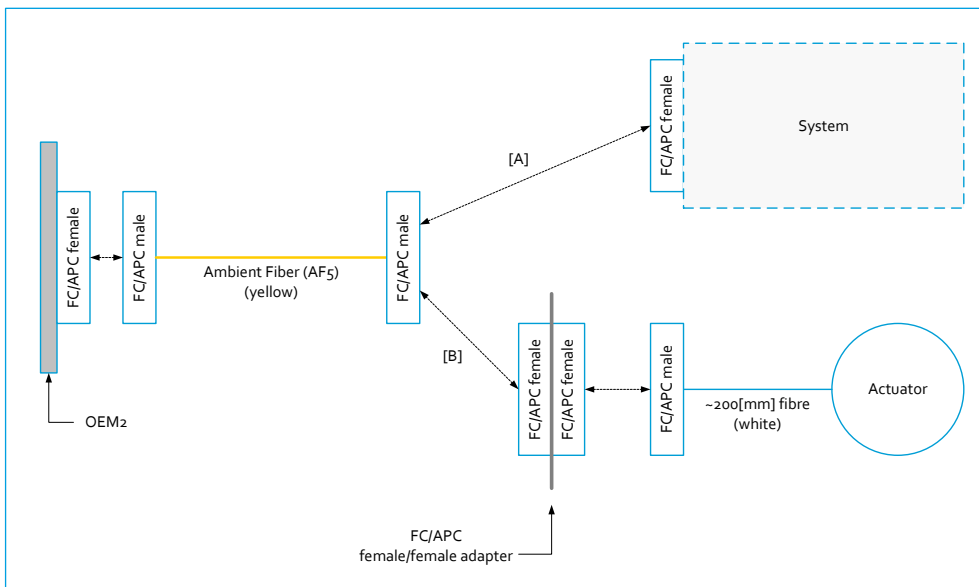
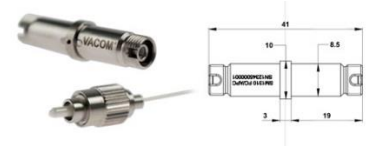



Figure 1: Default optical connections

Recommended optical components for in cryo-vacuum		
Vacom KON-V-SM1310-[length]-FCAPC-DE ¹⁴	Optical fiber cable for Ultra High Vacuum (UHV), SM1310, FC/APC	
Vacom W-SM1310-FCAPC ¹⁵	Singlemode SM1310 range optical feedthrough with FC/APC coupling (weldable)	
Molex 106152-3000	FC Adapter, APC, Metal Body, Ceramic Alignment Sleeve, D-Hole Mount Style, Tight Fit Key	

¹⁴ Various lengths available, visit the Vacom webshop for more information.

¹⁵ Also available for flange mount, or already welded in standard flanges. Visit the Vacom webshop for more information.

6. CLEANING OF PARTS

Actuators, systems or accessories have no specific cleaning requirements prior to use. Should it be necessary, parts can be cleaned carefully with IPA (Isopropyl alcohol) using polyester swabs and/or non-woven dry cleanroom wipes.

Never submerge actuators, systems of accessories in any liquid!

Always use (powder free, nitrile) gloves to handle all parts that are destined to be used in a cryostat and/or vacuum chamber. Follow common cleanroom practices when handling actuators, systems or accessories.

Recommended cleaning materials	
Texwipe TX8270	70% IPA (Isopropyl alcohol).
Texwipe Technicloth TX609	Non-woven dry cleanroom wipes.
Texwipe TX741B	Swabs with polyurethane foam.