

MANoo – GETTING STARTED GUIDE

CRYO & NANO PRODUCTS

JPE



+31 (0) 43 3585 777

www.jpe.nl

Aziëlaan 12

6199 AG Maastricht-Airport
The Netherlands

Property of: JPE

Author: JPE

Filename: CNP_MANoo_Ro7_Getting-Started.docx

Page 1 / 18

Last update: 2024-05-21

Revision: 07

Doc status: Released

CONTENTS

1. INTRODUCTION	4
1.1 Document version	4
2. APPLICABLE DOCUMENTS	5
2.1 Products User Manual	5
2.2 Software User Manual	5
2.3 Connection Overview application note	5
3. SAFETY	6
3.1 Instructions	6
3.2 Safety Rules	6
3.3 Audible Sound	7
4. GETTING STARTED	8
4.1 Inside the box	8
4.2 Setup for first time use	8
4.3 Installing additional Modules in an existing Controller (CPSC1)	12
5. INTERFACING & CABLING	13
5.1 Electrical components	13
5.2 Optical components	16
5.3 Altering Ambient Cables (ACL)	17
6. CLEANING OF PARTS	18

RELEVANT DOCUMENTATION

Ref	Title, Author
[1]	
[2]	
[3]	
[4]	
[5]	

DOCUMENT HISTORY

JPE	2019-07-15	Ro1. Creation.
JPE	2020-09-18	Ro2. Update.
JPE	2020-10-15	Ro3. Update.
JPE	2021-01-15	Ro4. Update.
JPE	2021-06-30 2021-10-04	Ro5. Update. Ro5. Section 3.3 added. Chapter 5 updated.
JPE	2022-03-18 2023-01-02	Ro6. Update to reflect CPSC1 release. Ro6. Updated sections 2.1, 4.2 and 5.1.
JPE	2024-05-21	Ro7. Updated sections 4.1, 4.2 and 5.1.

DEFINITIONS

ABBREVIATIONS

1. INTRODUCTION

Thank you for using JPE's Cryo & Nano Products!

This *Getting Started Guide* describes the hardware installation and setup of JPE's cryogenic compatible positioners, actuators and stages (from here on described as positioner, actuator or stage). These products can be operated by using a (modular) Controller System (from here on described as controller).



Please read this document carefully prior to installation and (initial) operation of the controller, (stand-alone) positioners, actuators and stages. Failure to observe the safety regulations results in a risk of electric shock and/or damage to the controller(s), positioner(s), actuator(s) and/or stage(s)!

JPE shall not be liable for damage or injury resulting from misuse of the controller(s), positioner(s), actuator(s) and/or stage(s) or unauthorized alterations to either of those.

All products mentioned in this manual are intended for use in a laboratory and/or scientific research environment only and may only be installed, maintained and used by higher educated, technical skilled personnel (from here on described as operators).

1.1 Document version

This *Getting Started Guide* assumes using the latest products and controller firmware: **v8.o.yyyymmdd**.

Please note that all content in this document is superseded by any new versions of this document. Visit the JPE website (www.jpe-innovations.com) to obtain the most recent version. All images in this document are for illustrative purposes only.

2. APPLICABLE DOCUMENTS

Alongside this *Getting Started Guide* there are other manuals that need to be consulted prior to using the products.

2.1 Products User Manual

Each product has its own separate *User Manual (MANo1-xx)*, which can be found at the product page of each individual product on the JPE website. These manuals include electrical and/or optical connection diagrams or specific unpacking instructions for example.

MANo1-01	Cryo Linear Actuator (CLA)
MANo1-02	Cryo Positioning Systems High Resonance (CPSHR)
MANo1-03	Cryo Bearing Stage (CBS)
MANo1-04	Cryo Stage o2 (CSo2)
MANo1-05	Cryo Translation Stage (CTS) (<i>discontinued</i>)
MANo1-06	Cryo Linear Drive (CLD)
MANo1-07	Cryo Tip/Tilt/Piston Stage (CTTPS)
MANo1-08	Cryo Rotary Motor (CRM)
MANo1-09	Cryo Positioning Systems Controller (CPSC) (<i>discontinued</i>)
MANo1-10	Cryo Vibration Isolation Platform (CVIP)
MANo1-11	Nano Stepper Actuator UHV (NSAU)
MANo1-12	Cryo Linear Scanner (CLS)
MANo1-13	Cryo Voice Coil Actuator (CVCA)
MANo1-14	Cryo Positioning Systems Controller 1 (CPSC1)
MANo1-15	Cryo Sample Rotator (CSR)

2.2 Software User Manual

Read the *Software User Manual (MANo2)*¹ on how to operate positioners, actuators or stages using the controller. This manual includes a detailed instruction list describing all the functions of the controller.

2.3 Connection Overview application note

Although all required information is available in the individual product user manuals, interface drawings and brochures, it is helpful to have a simplified but clear connection overview of how to connect stages, positioners or actuators to the controller. For this the *CNP Connection Overview application note (APNo1)*² is available for download on the JPE website and it is highly recommended to use this application note as a reference manual as well.

¹ Visit www.jpe-innovations.com > Cryo & Nano Products > Cryo Positioning Systems Controller 1 (CPSC1) > (tab) Software

² Visit www.jpe-innovations.com > Cryo & Nano Products > {any product page} > (tab) Downloads

3. SAFETY

3.1 Instructions

In this and all available products related documents (see chapter 2), important (mostly safety related) information is shown inside a (red colored) solid line bordered box, like this:

Important notes are shown inside a bordered box.

Please note that it is obligatory to follow the instructions mentioned in these bordered boxes! Failing to observe instructions may result in a risk of electric shock! Therefore, follow all instructions carefully!

General tips and tricks for handling and using the products are shown inside a (blue colored) dashed bordered box, like this:

Tips and tricks are mentioned inside a dashed bordered box.

3.2 Safety Rules

- 1 Assembly and mounting of positioners, actuators and stages may only be carried out when not (electrically or optically) connected to the controller.*
- 2 Always check all cabling, wiring and connectors (electrical as well as optical) on defects prior to connecting to positioners, actuators, stages or controllers. Please note that electrical wires and optical fibers to positioners, actuators and (inside) stages can be fragile parts and should always be handled with great care!*
- 3 Positioners, actuators and stages must only be connected to the controller when all positioners, actuators and stages have been placed in a safe environment towards the operator(s), i.e. out of reach by the operator(s) when driving them electrically (by using the controller).*
- 4 **Because of design constraints, open voltage contacts can be present!** Therefore, touching positioners, actuators and stages including all cabling and connectors while driving electrically, is not allowed and may result in a dangerous electrical shock! Avoid physically touching unconnected in- or outputs when the controller is powered ON.*
- 5 Always place the controller(s), positioner(s), actuator(s) and stage(s) on a sturdy surface or mount, the controller at level (and preferably) on a bench top, desk or 19" rack, and away from any wet or damp locations. Do not cover the top of the controller cabinet! In case of installing in a 19" rack, keep at least 2U (ca 90mm) height free above the cabinet.*
- 6 Positioner(s), actuator(s) and stage(s) can be used in vacuum (vacuum chamber) and/or cryogenic environment (cryostat). Positioner(s), actuator(s) and stage(s) must only be operated when the environment is in a defined state. Recommended pressure levels are: $\leq 1e^{-3}$ [mbar] or normal ambient conditions. Operating in between these pressure levels is not recommended in order to reduce the risks of electric arcing (Paschen's Law).*

- 7 *Do not use the controller in any other way than to operate positioners, actuators and stages supplied by JPE and do not operate positioners, actuators and stages in any other way than by using the controller supplied by JPE.*
- 8 *The controller is designed to be powered by commonly used 230V AC (European version) or 115V (US version) via a socket with protective earth. Note that it is not possible to switch in between both (i.e. the ordered controller is either the 230V version or the 115V version). Always ensure proper grounding via the protective earth connection of the power inlet.*
- 9 *Do not turn ON the controller immediately after it has been brought from a cool into a warmer environment (risk of condensing water) or vice versa. After unpacking, wait at least 4 hours before using the controller.*
- 10 *Always keep (metal) screw-on caps on the ends of unconnected (optical) cabling and connectors.*
- 11 *Always handle positioners, actuators and stages using (powder free, nitrile) gloves and store the products in a closed box when not in use to keep them as clean as possible.*

3.3 Audible Sound

Please note that most positioners, actuators and stages will make a (loud) audible sound, depending on the chosen parameters to drive them. Typically, *Step frequency* and *Relative step size*³ will have the most impact on how the product sounds, as well as the mechanics and the driving element (piezo) that is used. In general consider: the higher the parameter value, the louder it'll sound.

Although sound levels are generally below harmful levels (typically around 70dB max. for a CBS positioner or around 78dB max. for a CLD positioner), the pitch can be tedious (especially when hearing for a longer period of time). Therefore, it is recommended to use ear plugs when using the products for a longer period of time.

³ Please see the Software User Manual (MANo2) for more information.

4. GETTING STARTED

4.1 Inside the box

Because of the rigid packaging, beware of possible rough/sharp edges in any of the packaging materials when opening the box(es).

Depending on the ordered products, the delivery will consist of one or more large white JPE-branded cardboard shipping box(es). Typically:

- [1x] Shipping box containing:
 - [1x or more] white-colored (membrane) polypropylene box(es) with the ordered number of positioners, actuators and/or stages.
 - [1x or more] cardboard box(es) containing any product specific accessories or connector interface kits.

- [1x] Shipping box containing:
 - [1x] Controller (CPSC1) that consists of a Base Cabinet (CAB) with the ordered plug-in modules (for example CADM, RSM or OEM) already installed.
 - [1x] cardboard box with:
 - [1x] mains power cable
 - [1x] USB A to B cable

Carefully unpack everything and pay special attention to the white-colored (membrane) polypropylene box(es): the inner part of the polypropylene box can be taken out and bend in such way that the products can be easily unpacked. In some cases, the products are fixed onto the inner part of the polypropylene box with fasteners instead of being locked underneath the membrane plastic.

Do not cut the membrane plastic of any of the boxes. Keep the packaging aside in case products need to be returned.

Before continuing, check all parts for any visible defects. If anything found or when in doubt, please contact JPE for further assistance.

4.2 Setup for first time use

Follow all safety rules as listed in Chapter 3!

This following guide assumes connecting the controller to a computer running Windows OS via USB (Virtual COM port) and using general-purpose terminal programs like RealTerm⁴ or PuTTY⁵. Please refer to the Software User Manual for a detailed guide on how to operate positioners, actuators and stages via the other available connection options (Ethernet LAN, RS-422).

⁴ <https://realterm.sourceforge.io/>

⁵ <https://www.putty.org/>

On the JPE website there is also a download available⁶ containing Python Demo (GUI) scripts that can be used to get up and running quickly instead of using a terminal program like RealTerm or PuTTY. To follow along with the guide below, please use the [CPSC1_BaseDrive_GUI](#) script.

Please do note that these scripts are simply demo's – JPE encourages users to develop their own higher-level control / user software.

- 1 Unpack and mount the positioner(s), actuator(s) or stage(s) according to any specific instructions mentioned in the product's User Manual. For an initial test run, use only supplied standard cabling and/or connector kits. Please refer to the product User Manual(s)⁷ or the *Connection Overview application note*⁸ for more detailed information on how to connect the products to the controller.

Always make sure positioner(s), actuator(s) or stage(s) are firmly mounted to a solid base (fixed world) using the proper mounting interfaces, otherwise erratic motion may occur.

- 2 Place the controller on an appropriate surface (for example a sturdy workbench) and make sure that no positioners, actuators or stages are connected to the controller.
- 3 Check that the Mains Power Switch on the back of the controller cabinet is in the OFF ("0") position, connect the supplied mains power chord to the IEC inlet on the back and plug the power chord into a protective contact power socket. Make sure the mains power matches the rated input voltage (label on back panel) and that the top of the cabinet is not covered! (When installed in a 19" rack, make sure at least 2U above is free.)
- 4 Connect the supplied USB cable to the back of the cabinet (connector labelled "USB") and on the other end into a free USB port on the host computer.
- 5 Connect each positioner, actuator or stage to the controller modules.

For easy reference, make a note which positioner, actuator or stage is connected to which output and/or input.

- 6 Power on the cabinet, switch the Mains Power Switch to the ON ("1") position.
- 7 Windows should automatically detect new hardware. Go to the Windows *Device Manager* and look for a newly added COM port. This should look something like the screenshot below. Note that the port number (COMx) will be assigned by Windows.

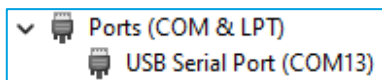

- 8 Start a terminal program like RealTerm to send commands to the controller and read responses from the controller. By default, the following settings must be used to open the (virtual) COM port:

⁶ Visit www.jpe-innovations.com > Cryo & Nano Products > Cryo Positioning Systems Controller 1 (CPSC1) > (tab) Software

⁷ See section 2.1

⁸ See section 2.3

Baudrate (Baud)	115200
Parity	None
Data bits	8
Stop bits	1
Hardware flow control	None
End Of Line (EOL)	CR & LF

The screenshots below show how this is configured in **RealTerm**:

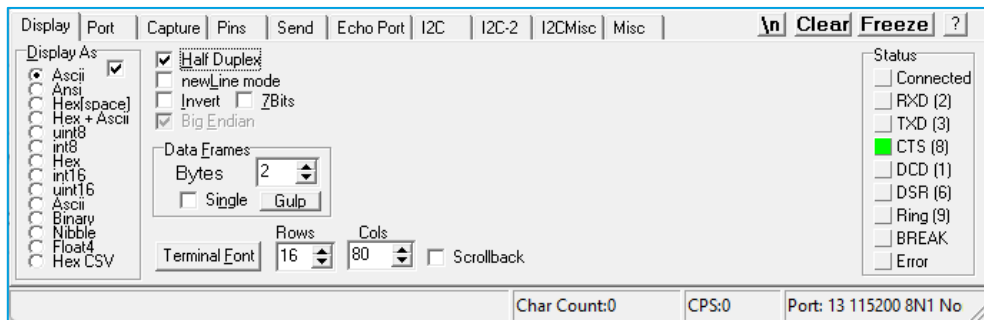
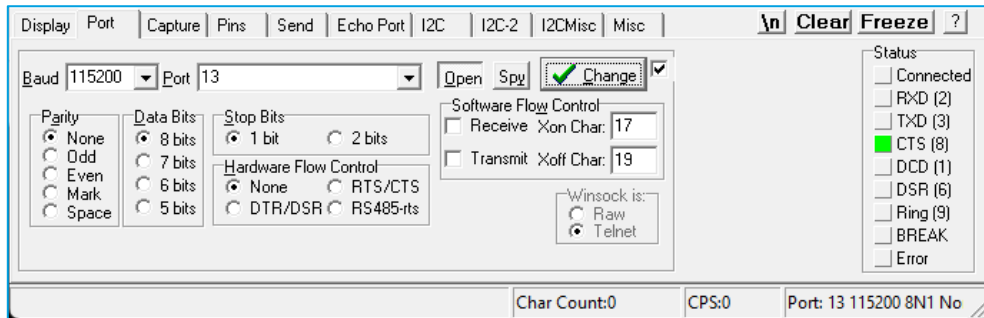

For readability, in the *Send*-tab under **EOL** check the boxes "+CR", "+LF" and under `\n` check "After":

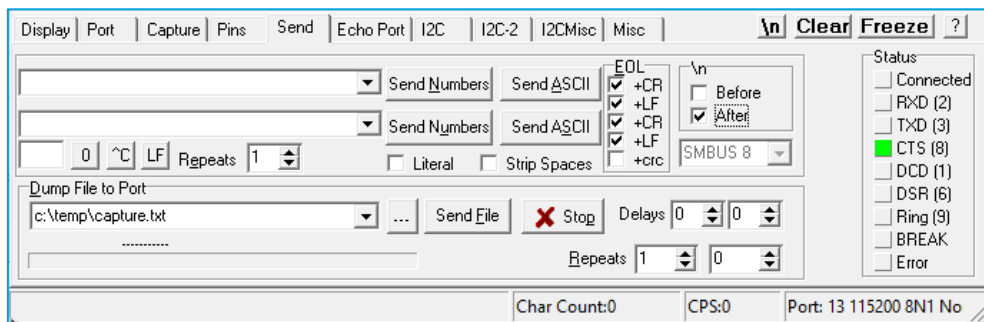

When using the CPSC1_BaseDrive_GUI script, it is only required to set the correct COM port number (COMx) and the correct BaudRate (Speed).

- 9 After the terminal program has established a connection, type: `/MODLIST` in the input box and click the [Send ASCII] button. The controller should return a comma-separated list of all detected modules in the controller, for example: `CADM2,CADM2,CADM2,RSM,EDM` (where in the example all 6 slots have a module installed).

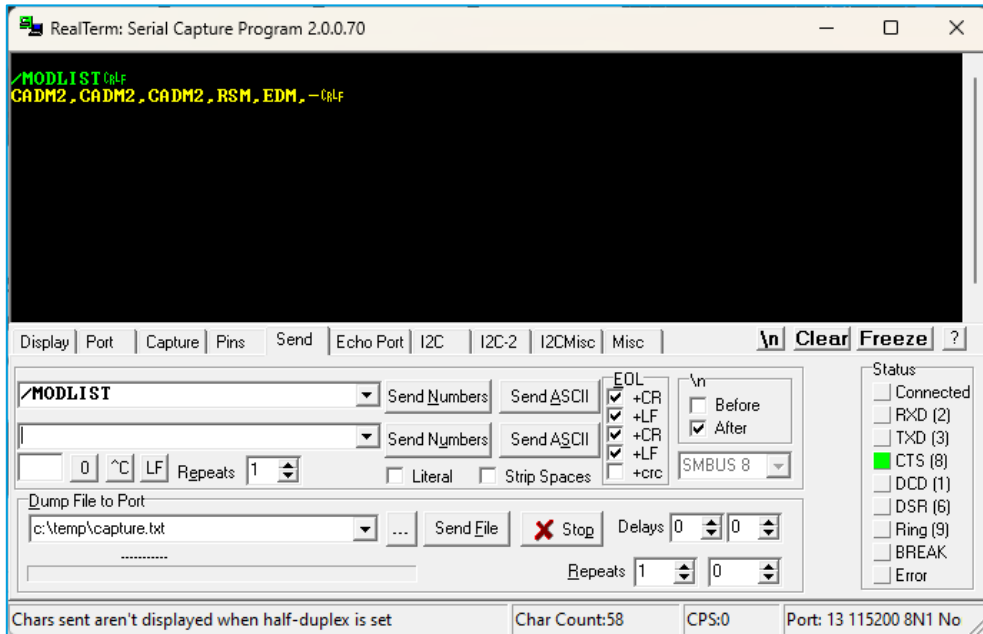

When using the CPSC1_BaseDrive_GUI script, click the "Info" button. This will display all installed modules including firmware versions in the Command History window of the GUI.

- 10 Now send the `MOV`-command to start moving an actuator. When using a standard **CLA2601** type actuator connected to a **CADM2** module in **slot address 1**, you can use the example below to make the actuator do **321** (piezo) steps at **450Hz** and at full **100%** step size:

Command	MOV [ADDR] [DIR] [FREQ] [RSS] [STEPS] [TEMP] [STAGE] [DF]
Command (example)	MOV 1 1 450 100 321 293 CLA2601 1
Response (example)	Actuating the stage.

After completing 321 steps, the actuator will automatically stop moving (which, at 450Hz, will only take about 0.7 [sec]).

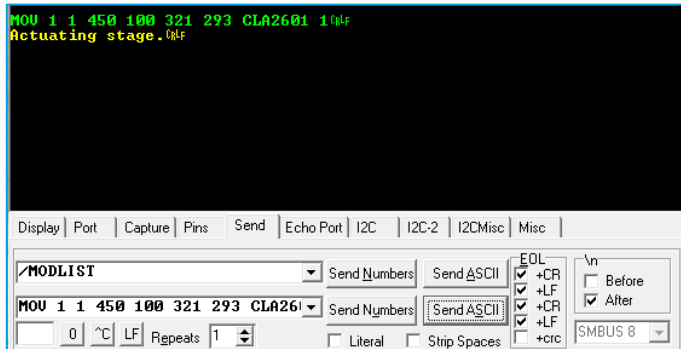

This is only a basic example, please consult the *Software User Manual* for more details on all available commands.

When using the CPSC1_BaseDrive_GUI script, set the correct parameter values and click the "DIR=1"-button to execute the MOV-command.

- 11 Make sure to turn the controller OFF ("o") before disconnecting any positioners, actuators or stages from the controller.

4.3 Installing additional Modules in an existing Controller (CPSC1)

Up to 6 function specific modules can be installed in one Base Cabinet (CAB). If additional modules are ordered after initial delivery, these modules can be installed by the customer upon delivery by following the instructions in this section.

- 1 Make sure to unplug the Base Cabinet from the mains supply and wait for at least 10 minutes before inserting (or removing) any Module.
- 2 To insert a module, unscrew the blank filler panel at the first available position (as seen from left to right at the front of the cabinet).

If a sensor (OEM2 or RSM) module is already installed, make sure that the sensor module is always on the right-hand side of all driver (CADM2) modules! So, if necessary, move the sensor module as well. For example:

Slot	Old situation	Incorrect new situation	Correct new situation
1	CADM2	CADM2	CADM2
2	CADM2	CADM2	CADM2
3	OEM2	OEM2	(new) CADM2
4		(new) CADM2	OEM2
5			
6			

- 3 Make sure to tighten all 4 screws of the Module prior to power on of the cabinet.

5. INTERFACING & CABLING

Because each customer setup is different and there are many options depending on the cryostat or vacuum chamber that is being used, JPE does not supply feedthroughs or additional specific connectors by default.

However, a solution based on industry standard 15p male-male D-Sub type feedthroughs can be offered with connector kits like the I1-ACL, I1-RSM and CCL and/or CCR cabling. In this situation the customer only has to arrange and install one or more D-Sub male-male feedthroughs.

Please refer to the Connection Overview application note (CNP APNo1) for more information about this subject and the CPSC1 Hardware User Manual (MANo1-14) for detailed information on the available cabling and connector interface kits.

In some situations, a customer might want to construct their own cabling and connectors. This chapter can be used as a reference for connecting and constructing additional (electrical or optical) cabling in between positioner(s), actuator(s) or stage(s) and the controller.

It is not allowed to make any alterations to the connector, connector interface PCB or FPC (flexible printed circuit) of positioners, actuators or stages.

Make sure to test all positioners, actuators and stages with only the supplied cabling first, before connecting any additional cabling for the intended setup in which the positioners, actuators and stages are to be used.

Please note that any soldering must be carried out by qualified personnel only and do double-check correct pin wiring afterwards. Make sure to properly clean any solder residues before placement inside a vacuum chamber or cryostat.

Visually check for cable faults and check for possible shorts in between wires and/or in between wires and the position, actuator or stage itself (using a multi-meter) after connecting any additional cabling.



JPE does not assume liability for damages to property or personal injury!

5.1 Electrical components

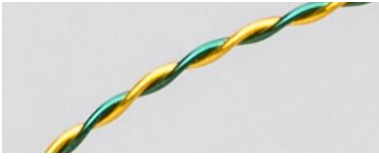

To support customers with their own custom cabling, JPE can offer an accessory kit that contains typically used electrical connectors and interfaces to extend wiring (Accessory Kit Electrical 1 – AKE1). The list below shows which recommended parts are available in the AKE1.

The total DC resistance of all wiring per positioner or actuator (CADM/PSM output to positioner / actuator) should not exceed 10[Ω]. The Ambient Cable (ACL) has a resistance of less than 0.5Ω/m. If any other cabling is to be used, it is recommended to use wires with a rated voltage of (at least) 200[V] and a rated current of (at least) 1[A] continuously.

The total DC resistance of all wiring per sensor (RSM output to sensor) is not very critical. If any other cabling is to be used, it is recommended to use wires with a rated voltage of (at least) 50[V] and a rated current of (at least) 0.1[A] continuously.

Recommended wiring		
Lakeshore Duo-Twist DT-32	Cryogenic wire, 32AWG phosphor bronze twisted pair ⁹	
Allectra 301-KAPM-035¹⁰	Kapton isolated wire, UHV compatible, 28AWG, multi-strand silver plated copper wire 7x0.12mm. <i>Recommended for positioners and actuators.</i>	
Allectra 301-KAPM-025	Kapton isolated wire, UHV compatible, 32 AWG, multi-strand silver plated copper wire, 7x.0.08mm. <i>Recommended for sensors, but can also be used for positioners and actuators.</i>	

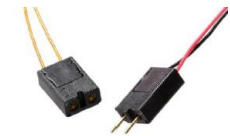
Always check visually for cable or wire faults or possible shorts in between wires and/or in between wires and the positioner(s) / actuator(s) / stage(s) itself (by using a multi-meter) after installation in the final setup and before connecting them to the controller module(s).

Recommended feedthroughs and connectors		
JPE UCC	UHV Cryogenic Connector, PPS, solder terminals. Suitable for wiring up to AWG28. Available in 2-pin and 3-pin ¹¹ male-female configuration.	
Molex KK 22-01-3027¹² (available in the AKE1)	KK® 254 Crimp Housing, Friction Ramp, 2 Circuits, nylon	

⁹ Most suitable for in cryogenic applications, however wire is difficult in use (fragile insulation, difficult routing) and the electrical resistance is relatively high (so keep length to bare minimum). Also available as Quad-Twist (QT-32) (2x twisted pair).

¹⁰ Also available as ribbon cable (301-KAP-RIB04 for example)

¹¹ 3-pin coming soon – please inquire for lead time



¹² Also available in various other number of circuits

<p>Molex KK 08-50-0032¹³ (available in the AKE1)</p>	<p>KK® 254 Cat Ear Crimp Terminal 4809, 22-30 AWG, Hot Tin Dip, Bag</p>	
<p>Molex KK 22-27-2021 (or Molex KK 22-05-7028) (both available in the AKE1)</p>	<p>KK® 254 Wire-to-Board Header, Vertical (or Right-Angle), with Friction Lock, 2 Circuits, Tin (Sn) Plating, nylon</p>	
<p>JPE P182189A (available in the AKE1)</p>	<p>1x 4p RLS (flex PCB) to 4x solder pads PCBA (Kapton foil PCB with 0.6mm stiffener). <i>For sensors only!</i></p>	
<p>Alletra 360-SC1X4-1.8¹⁴</p>	<p>PEEK Connector Block, UHV compatible, 4 pins, 1x4 contacts</p>	
<p>Alletra 211-FS15-PK</p>	<p>Sub-D Socket, female, 15pins, PEEK UHV</p>	
<p>Alletra 212-PINF-15</p>	<p>15x Crimp pins for Sub-D, female UHV & HV</p>	
<p>Alletra 211-MS15-PK</p>	<p>Sub-D Plug, male, 15pins, PEEK UHV</p>	
<p>Alletra 212-PINM-15</p>	<p>15x Crimp pins for Sub-D male, UHV & HV</p>	
<p>Vacom PLUG-SUBD-15-P¹⁵</p>	<p>Subminiature D Type (D-SUB) UHV PPS connector, 15p Female.</p>	

¹³ Lakeshore Duo-Twist DT-32 (or Quad-Twist QT-32) requires soldering wire to contact (crimp not possible as wire is too thin).

¹⁴ Also available in 1x6, 1x8 or 2x2 contacts, visit the Alletra webshop for more information.

¹⁵ Also available in 9p, 25p, 37p or 50p version, visit the Vacom webshop for more information. PPS is a thermoplastic material similar to PEEK, but with lower water absorption and outgassing (and most likely more cost-efficient than PEEK).

Vacom EK-SUBD-F-AWG22-25ST¹⁶	UHV female crimp pins for use with Vacom D-SUB UHV PPS Connector	
Vacom W-SUBD-15-BASIC¹⁷	15 pin Sub-D feedthrough acc. MIL-C-24308, weldable	
Würth WR-FPC 1.00mm SMT ZIF Horizontal Top Contact¹⁸	Zero Insertion Force (ZIF) 1mm pitch connectors for use with FPC (flexible printed circuits). <i>For sensors only!</i>	

5.2 Optical components

If additional optical fiber cabling is required, make sure to use FC/APC patch cables only. The default connection scheme, using standard Ambient Fibers (AF5) can be seen in the schematic overview below.

Connection options	
[A]	Applies when connecting stages like CPSHR
[B]	Applies when connecting single positioner or actuator with the –COE option, it is required to insert the FC/APC female/female adapter (one for each positioner or actuator will be supplied).

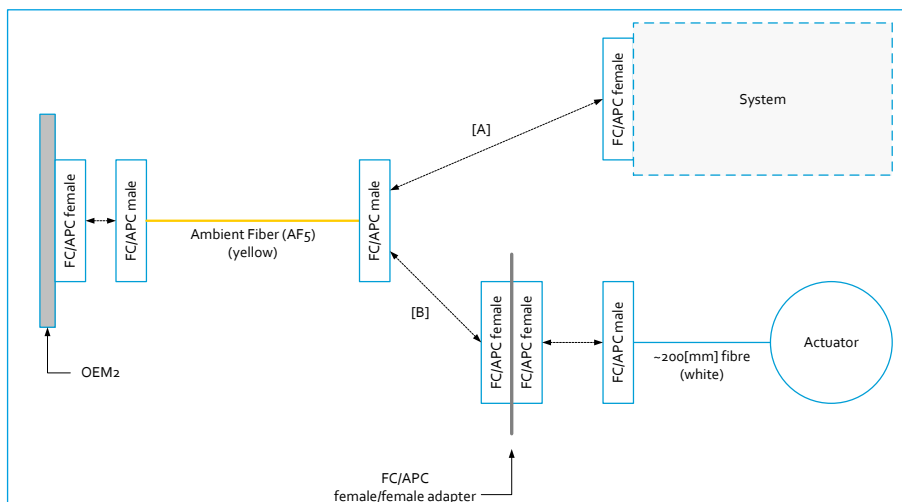



Figure 1: Default optical connections

¹⁶ Requires specific crimp tool, but wires can also be soldered to pins. Also available for AWG26-28 wiring. Visit the Vacom webshop for more information.

¹⁷ Also available in 9p, 25p, 37p or 50p or already welded in KF or CF flange, visit the Vacom webshop for more information.

¹⁸ For use with products that have the *Resistive Linear Sensor (-RLS)* option. Typically, the 4-pin version with top contacts is used. Connector insulator material is PPS. PPS is a thermoplastic material similar to PEEK, but with lower water absorption and outgassing.

Recommended optical components for in cryo-vacuum		
Vacom KON-V-SM1310-[length]-FCAPC-DE¹⁹	Optical fiber cable for Ultra High Vacuum (UHV), SM1310, FC/APC	
Vacom W-SM1310-FCAPC²⁰	Single mode SM1310 range optical feedthrough with FC/APC coupling (weldable)	
Molex 106152-3000	FC Adapter, APC, Metal Body, Ceramic Alignment Sleeve, D-Hole Mount Style, Tight Fit Key	

5.3 Altering Ambient Cables (ACL)

Although not recommended, it is allowed to detach (de-solder) the Molex socket connector for final integration in the Customer's setup (for example to connect to a customer specific feedthrough). It is vital to make sure that *Signal (SIG)* and *Reference (REF)* wires are not mixed up when soldering the cable to a different connector!

JPE recommends the use of the Ambient Connector Kit for ACL (I1-ACL) to easily connect up to 6x ACL to a 15p D-Sub interface.

It is not allowed to alter the LEMO connector on the Ambient Cable.

¹⁹ Various lengths available, visit the Vacom webshop for more information.

²⁰ Also available for flange mount, or already welded in standard flanges. Visit the Vacom webshop for more information.

6. CLEANING OF PARTS

Positioners, actuators, stages or accessories have no specific cleaning requirements prior to use. Should it be necessary, parts can be cleaned carefully with IPA (Isopropyl alcohol) using polyester swabs and/or non-woven dry cleanroom wipes.

Never submerge positioners, actuators, stages or accessories in any liquid!

Always use (powder free, nitrile) gloves to handle all parts that are destined to be used in a cryostat and/or vacuum chamber. Follow common cleanroom practices when handling positioners, actuators, stages or accessories.

Recommended cleaning materials	
Texwipe TX8270	70% IPA (Isopropyl alcohol).
Texwipe Technicloth TX609	Non-woven dry cleanroom wipes.
Texwipe TX741B	Swabs with polyurethane foam.